

Circus

0130

AM
STUDIO
CUSTOM LIGHTING

VIBIA

Design By Antoni Arola

Circus versatile accent spotlight allows design professionals to define spaces and create diverse scenes. With narrow angles under 20°, it's ideal for generating high contrasts or projections at far distances.

Spec sheet

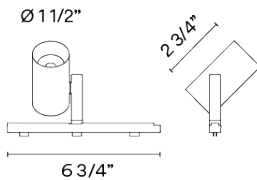

undefined: undefined

Any modifications require a minimum order quantity and extra lead time

Finish	 24 Beige M1 NCS S 2005-Y50R
	 11 Black NCS S 8500-N
LED	2700 K / 3000 K / 3500 K
Dimming	0-10V / DALI 0-10V 1-10V / CASAMBI

Installation type To track

LED	CRI>90 680 lm 94,4 2700 K / 3000 K / 3500 K
Driver	Constant Current 400 42 V - 48 V V <input checked="" type="checkbox"/> LED <input checked="" type="checkbox"/> IP20 <input checked="" type="checkbox"/> 
Application	Pendants
Packaging	Box
	Gross weight
	Net weight

Lighting effect

Accent Spotlight

Narrow: Angles less than 20°. Suitable for generating high contrasts or projections at far distances.

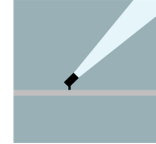

Photometric Data

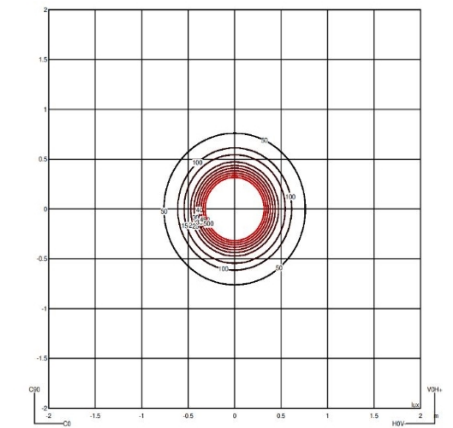
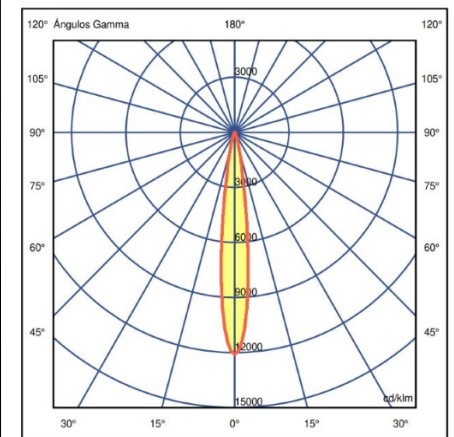

Efficiency	76.753 lm/W
Coordination System	CG
Total Flux	575.6 lm
Maximum Value	12087.14 cd/klm

All of our products come with a two year standard warranty. Check US & Canada Term and Condition sales@vibia.com

VIBIA, INC.

Office / Oficina
272 Fernwood Ave. Edison, NJ 08837. USA

International T 732 417 1700
Spain / Portugal T +34 934 796 970

sales@vibia.com
www.vibia.com/us/usa

Circus

0131

Design By Antoni Arola

VIBIA

The Circus accent spotlight defines spaces with medium contrasts and projections at moderate distances. This model allows for comprehensive color temperature control. By controlling the individual LEDs, you can precisely adjust the temperature from cool white to warm white or red, depending selected LED for the desired atmosphere.

Spec sheet

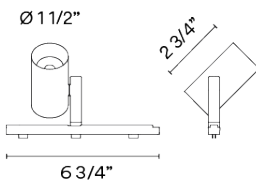

undefined: undefined

Any modifications require a minimum order quantity and extra lead time

Finish	 11 Black NCS S 8500-N
	 24 Beige M1 NCS S 2005-Y50R
LED	2700 K / 3000 K / 3500 K / Tunable Red / Tunable White
Dimming	DALI 0-10V 1-10V / 0-10V / CASAMBI

Installation type To track

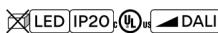
LED	CRI>90 680 lm 94,4 2700 K / 3000 K / 3500 K / Tunable Red / Tunable White
Driver	Constant Current 400 42 V - 48 V V 
Application	Pendants
Packaging	Box
	Gross weight
	Net weight

Lighting effect

Accent Spotlight

Narrow: Angles less than 20°. Suitable for generating high contrasts or projections at far distances.

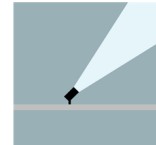

Photometric Data

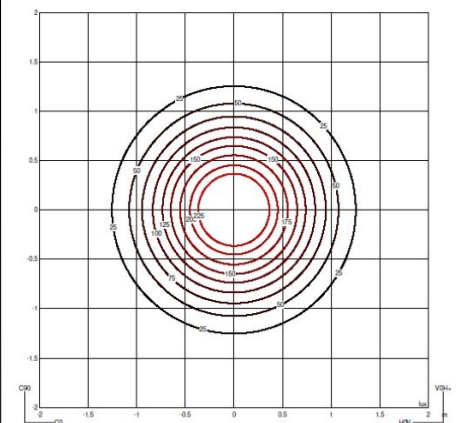
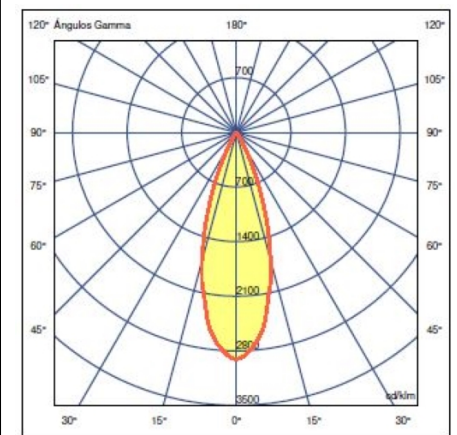

Efficiency	78.001 lm/W
Coordination System	CG
Total Flux	585.0 lm
Maximum Value	2905.10 cd/klm

All of our products come with a two year standard warranty. Check US & Canada Term and Condition sales@vibia.com

VIBIA, INC.

Office / Oficina
272 Fernwood Ave. Edison, NJ 08837. USA

International T 732 417 1700
Spain / Portugal T +34 934 796 970

sales@vibia.com
www.vibia.com/us/usa

Design By Antoni Arola

Circus with its focus of over 40° generates moderate contrasts and projections at close distances. This model gives options for static white or tunable white color temperature depending on the desired atmosphere.

Spec sheet

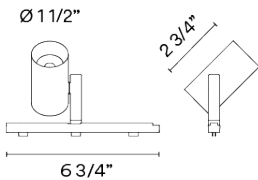

undefined: undefined

Any modifications require a minimum order quantity and extra lead time

Finish	 24 Beige M1 NCS S 2005-Y50R
	 11 Black NCS S 8500-N
LED	2700 K / 3000 K / 3500 K / Tunable White
Dimming	CASAMBI / DALI 0-10V 1-10V / 0-10V

Installation type To track

LED CRI>90 680 lm 94,4
2700 K / 3000 K / 3500 K / Tunable White

Driver Constant Current 400 42 V - 48 V V

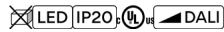

Application Pendants

Packaging Box

Gross weight
Net weight

Lighting effect

Accent Spotlight

Narrow: Angles less than 20°. Suitable for generating high contrasts or projections at far distances.

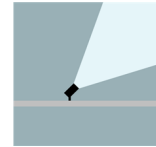

Photometric Data

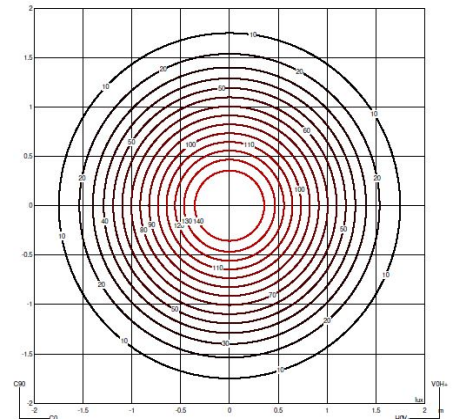
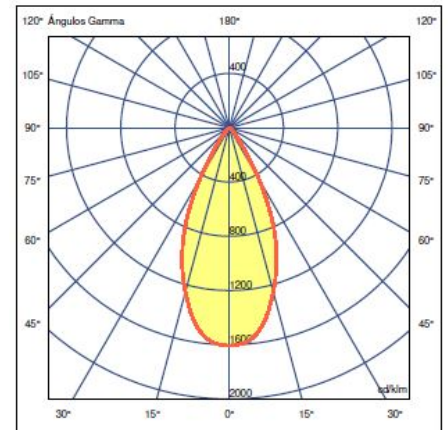

Efficiency	79.258 lm/W
Coordination System	CG
Total Flux	594.4 lm
Maximum Value	1606.43 cd/klm

All of our products come with a two year standard warranty. Check US & Canada Term and Condition sales@vibia.com

Design By Antoni Arola

Circus versatile accent spotlight allows design professionals to define spaces and create diverse scenes. With narrow angles under 20°, it's ideal for generating high contrasts or projections at far distances.

Spec sheet

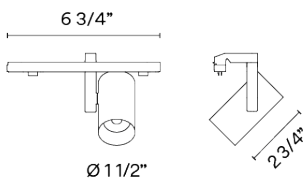

Any modifications require a minimum order quantity and extra lead time

Finish	<ul style="list-style-type: none"> 24 Beige M1 NCS S 2005-Y50R 11 Black NCS S 8500-N
LED	2700 K / 3000 K / 3500 K
Dimming	CASAMBI / DALI 0-10V 1-10V / 0-10V

Installation type To track

LED	CRI>90 680 lm 94.4 2700 K / 3000 K / 3500 K
Driver	Constant Current 400 42 V - 48 V V
	<input checked="" type="checkbox"/> LED <input checked="" type="checkbox"/> IP20 <input checked="" type="checkbox"/> Θ_{amb} <input checked="" type="checkbox"/> DALI
Application	Ceiling Fixtures
Packaging	Box
	Gross weight
	Net weight

Lighting effect

Accent Spotlight

Narrow: Angles less than 20°. Suitable for generating high contrasts or projections at far distances.

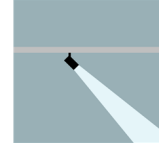

Photometric Data

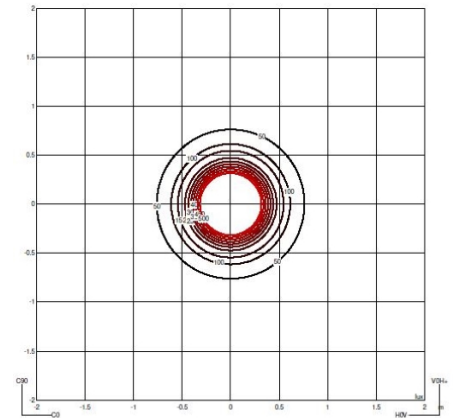
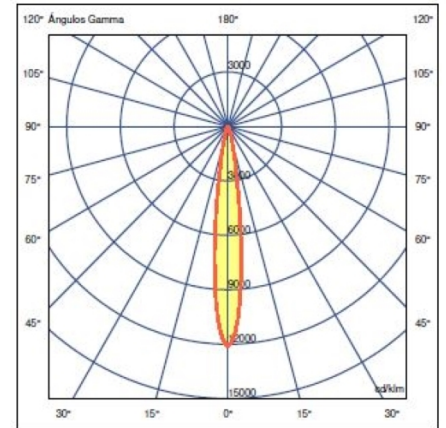

Efficiency	76.753 lm/W
Coordination System	CG
Total Flux	575.6 lm
Maximum Value	12087.14 cd/klm

All of our products come with a two year standard warranty. Check US & Canada Term and Condition sales@vibia.com

Circus

0136

VIBIA

Design By Antoni Arola

The Circus accent spotlight defines spaces with medium contrast and moderate distance projections. This model allows for comprehensive temperature regulation. By controlling the individual LEDs, you can precisely adjust the temperature from cool white to warm or red, depending on the LED selection for desired atmosphere.

Spec sheet

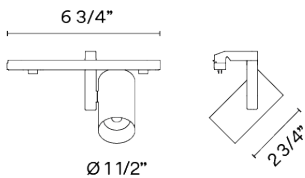

Any modifications require a minimum order quantity and extra lead time

Finish

- 11 Black
NCS S 8500-N
- 24 Beige M1
NCS S 2005-Y50R

LED 2700 K / 3000 K / 3500 K / Tunable Red / Tunable White

Dimming CASAMBI / 0-10V / DALI 0-10V 1-10V

Installation type To track

LED CRI>90 680 lm 94.4
2700 K / 3000 K / 3500 K / Tunable Red / Tunable White

Driver Constant Current 400 42 V - 48 V V

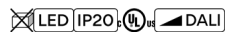

Application Ceiling Fixtures

Packaging Box

Gross weight
Net weight

Lighting effect

Accent Spotlight

Narrow: Angles less than 20°. Suitable for generating high contrasts or projections at far distances.

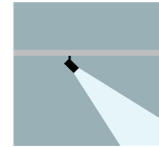

Photometric Data

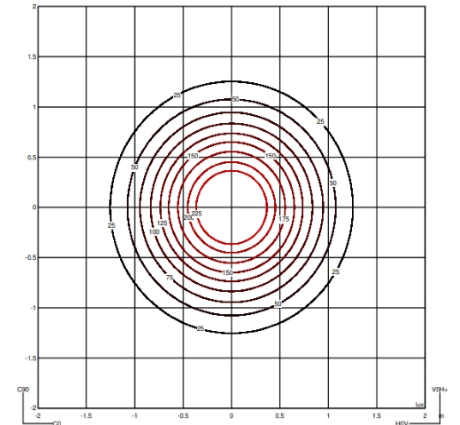
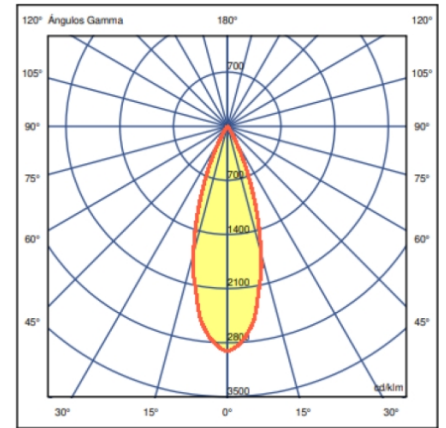

Efficiency 78.001 lm/W
Coordination System CG
Total Flux 585.0 lm
Maximum Value 2905.10 cd/klm

All of our products come with a two year standard warranty. Check US & Canada Term and Condition sales@vibia.com

VIBIA, INC.

Office / Oficina
272 Fernwood Ave. Edison, NJ 08837. USA

International T 732 417 1700
Spain / Portugal T +34 934 796 970

sales@vibia.com
www.vibia.com/us/usa

Design By Antoni Arola

Circus with its focus with an angle greater than 40° generates moderate contrasts and projections at close distances. This model allows precise adjustment of the white temperature from cold to warm or red, according to the desired atmosphere.

Spec sheet

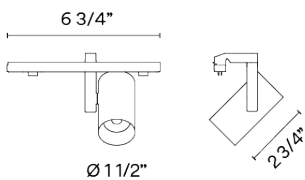

Any modifications require a minimum order quantity and extra lead time

Finish	<div style="display: flex; align-items: center;"> <div style="width: 15px; height: 15px; background-color: #c09070; border-radius: 50%; margin-right: 5px;"></div> <div> <p>24 Beige M1 NCS S 2005-Y50R</p> </div> </div> <div style="display: flex; align-items: center; margin-top: 10px;"> <div style="width: 15px; height: 15px; background-color: #1a1a1a; border-radius: 50%; margin-right: 5px;"></div> <div> <p>11 Black NCS S 8500-N</p> </div> </div>
LED	2700 K / 3000 K / 3500 K / Tunable White
Dimming	CASAMBI / 0-10V / DALI 0-10V 1-10V

Installation type To track

LED CRI>90 680 lm 94.4
2700 K / 3000 K / 3500 K / Tunable White

Driver Constant Current 400 42 V - 48 V V

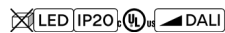

Application Ceiling Fixtures

Packaging Box

Gross weight
Net weight

Lighting effect

Accent Spotlight

Narrow: Angles less than 20°. Suitable for generating high contrasts or projections at far distances.

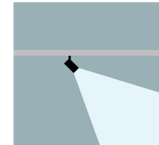

Photometric Data

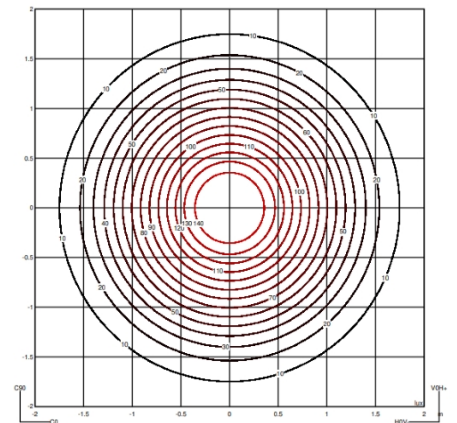
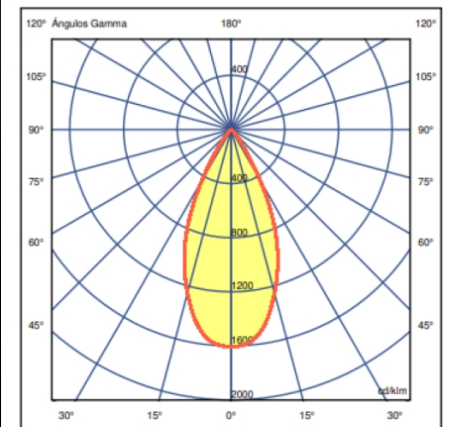

Efficiency	79.258 lm/W
Coordination System	CG
Total Flux	594.4 lm
Maximum Value	1606.43 cd/klm

All of our products come with a two year standard warranty. Check US & Canada Term and Condition sales@vibia.com

Design By Antoni Arola

The versatile pendant accent spotlight from Circus allows you to define spaces and create various scenes. With narrow angles less than 20°, it is ideal for creating high contrasts or projections at far distances.

Spec sheet

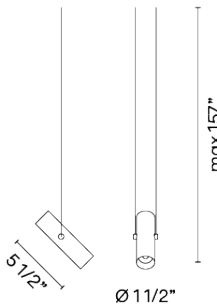
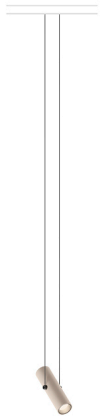

undefined: undefined

Any modifications require a minimum order quantity and extra lead time

Finish	<div style="display: flex; align-items: center;"> <div style="width: 15px; height: 15px; background-color: #c8a28c; border-radius: 50%; margin-right: 5px;"></div> <div> <p>24 Beige M1 NCS S 2005-Y50R</p> </div> </div> <div style="display: flex; align-items: center; margin-top: 10px;"> <div style="width: 15px; height: 15px; background-color: #1a1a1a; border-radius: 50%; margin-right: 5px;"></div> <div> <p>11 Black NCS S 8500-N</p> </div> </div>
LED	2700 K / 3000 K / 3500 K
Dimming	DALI 0-10V 1-10V / CASAMBI / 0-10V

Installation type To track

LED	CRI>90 680 lm 94.4 2700 K / 3000 K / 3500 K
Driver	Constant Current 400 48 V V
	<input checked="" type="checkbox"/> LED <input checked="" type="checkbox"/> IP20 <input checked="" type="checkbox"/> DALI
Application	Pendants
Packaging	Box
	Gross weight
	Net weight

Lighting effect

Accent Spotlight

Narrow: Angles less than 20°. Suitable for generating high contrasts or projections at far distances.

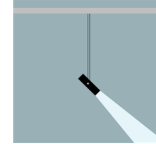

Photometric Data

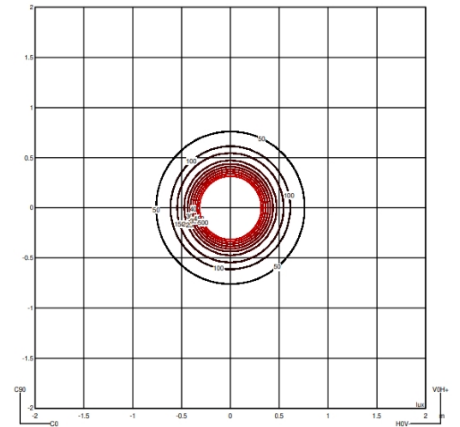
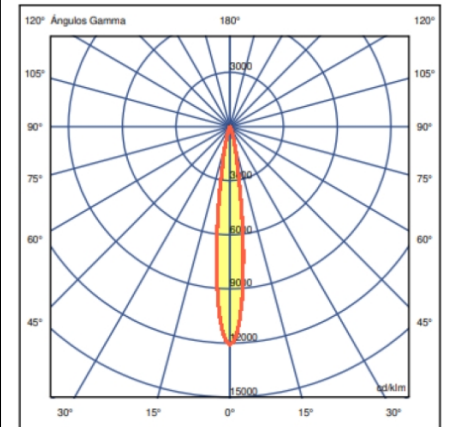

Efficiency	76.753 lm/W
Coordination System	CG
Total Flux	575.6 lm
Maximum Value	12087.14 cd/klm

All of our products come with a two year standard warranty. Check US & Canada Term and Condition sales@vibia.com

Design By Antoni Arola

The Circus pendant spotlight inspired by a trapeze artist provides defining spaces with medium contrasts and projections at moderate distances. This model allows for comprehensive temperature regulation. By controlling the individual LEDs, you can precisely adjust the temperature from cool white to warm or red, depending on the LED color temperature selection for desired atmosphere.

Spec sheet

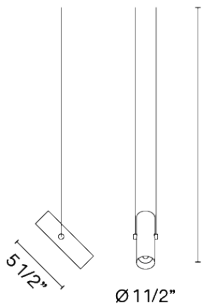
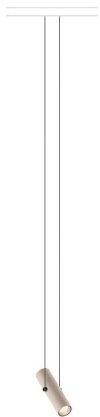

undefined: undefined

Any modifications require a minimum order quantity and extra lead time

Finish	<ul style="list-style-type: none"> 11 Black NCS S 8500-N 24 Beige M1 NCS S 2005-Y50R
LED	2700 K / 3000 K / 3500 K / Tunable Red / Tunable White
Dimming	DALI 0-10V 1-10V / CASAMBI / 0-10V

Installation type To track

LED	CRI>90 680 lm 94.4 2700 K / 3000 K / 3500 K / Tunable Red / Tunable White
Driver	Constant Current 400 42 V - 48 V V
	<input checked="" type="checkbox"/> LED <input checked="" type="checkbox"/> IP20 <input checked="" type="checkbox"/> DALI
Application	Pendants
Packaging	Box
	Gross weight
	Net weight

Lighting effect

Accent Spotlight

Narrow: Angles less than 20°. Suitable for generating high contrasts or projections at far distances.

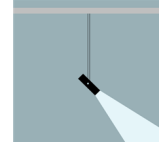

Photometric Data

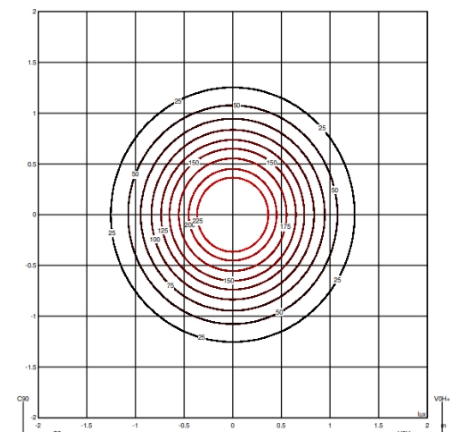
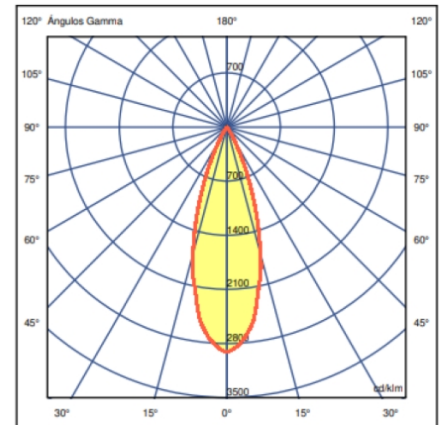

Efficiency	78.001 lm/W
Coordination System	CG
Total Flux	585.0 lm
Maximum Value	2905.10 cd/klm

All of our products come with a two year standard warranty. Check US & Canada Term and Condition sales@vibia.com

Design By Antoni Arola

Circus with its pendant focus over 40° generates moderate contrasts and projections at close distances. This model gives LED options for precise adjustment of the white temperature from cold to warm or red, according to the desired atmosphere.

Spec sheet

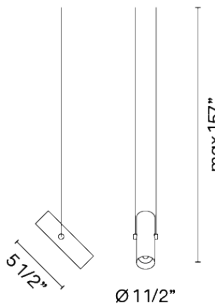
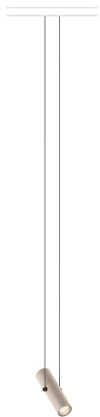

undefined: undefined

Any modifications require a minimum order quantity and extra lead time

Finish	<div style="display: flex; align-items: center;"> <div style="width: 15px; height: 15px; background-color: #c8a28d; border-radius: 50%; margin-right: 5px;"></div> <div> <p>24 Beige M1 NCS S 2005-Y50R</p> </div> </div> <div style="display: flex; align-items: center; margin-top: 10px;"> <div style="width: 15px; height: 15px; background-color: #1a1a1a; border-radius: 50%; margin-right: 5px;"></div> <div> <p>11 Black NCS S 8500-N</p> </div> </div>
LED	2700 K / 3000 K / 3500 K / Tunable White
Dimming	0-10V / CASAMBI / DALI 0-10V 1-10V

Installation type To track

LED CRI>90 680 lm 94.4
2700 K / 3000 K / 3500 K / Tunable White

Driver Constant Current 400 42 V - 48 V V

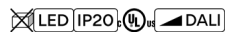

Application Pendants

Packaging Box

Gross weight
Net weight

Lighting effect

Accent Spotlight

Narrow: Angles less than 20°. Suitable for generating high contrasts or projections at far distances.

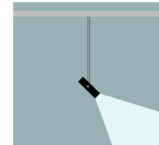

Photometric Data

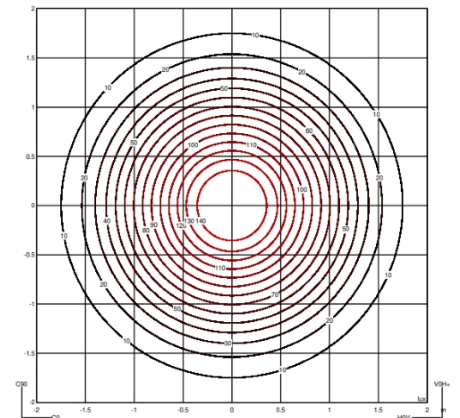
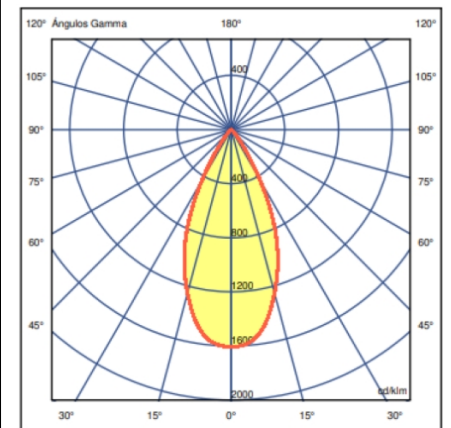

Efficiency	79.258 lm/W
Coordination System	CG
Total Flux	594.4 lm
Maximum Value	1606.43 cd/klm

All of our products come with a two year standard warranty. Check US & Canada Term and Condition sales@vibia.com

Design By Antoni Arola

The versatile Circus accent light allows design professionals to define spaces and create various scenes. With narrow angles of less than 20°, it is ideal for creating high contrasts or projections at far distances.

Spec sheet

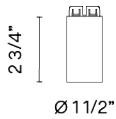

undefined: undefined

Any modifications require a minimum order quantity and extra lead time

Finish	<div style="display: flex; align-items: center;"> <div style="width: 15px; height: 15px; background-color: #c8a28c; border-radius: 50%; margin-right: 5px;"></div> <div> <p>24 Beige M1 NCS S 2005-Y50R</p> </div> </div> <div style="display: flex; align-items: center; margin-top: 10px;"> <div style="width: 15px; height: 15px; background-color: #1a1a1a; border-radius: 50%; margin-right: 5px;"></div> <div> <p>11 Black NCS S 8500-N</p> </div> </div>
LED	2700 K / 3000 K / 3500 K
Dimming	0-10V / DALI 0-10V 1-10V / CASAMBI

Installation type To track

LED	CRI>90 680 lm 94.4 2700 K / 3000 K / 3500 K
Driver	Constant Current 400 42 V - 48 V V
Application	Pendants
Packaging	Box
	Gross weight
	Net weight

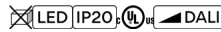

Lighting effect

Accent Downlight

Narrow: Angles less than 20°. Suitable for generating high contrasts or projections at far distances.



Photometric Data

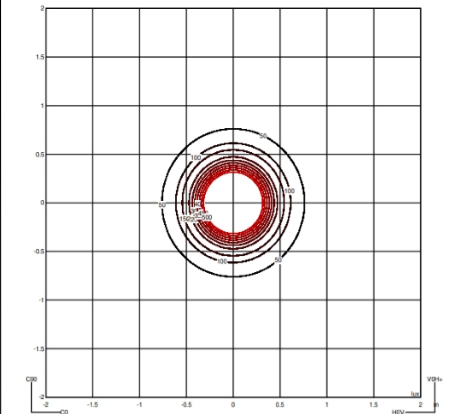
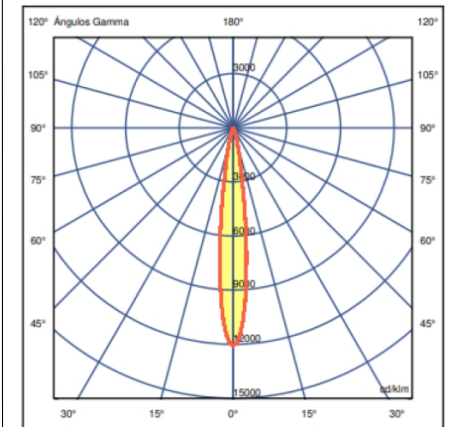

Efficiency	76.753 lm/W
Coordination System	CG
Total Flux	575.6 lm
Maximum Value	12087.14 cd/klm

All of our products come with a two year standard warranty. Check US & Canada Term and Condition sales@vibia.com

Design By Antoni Arola

The Circus accent spotlight defines spaces with medium contrasts and projections at moderate distances. This model allows for comprehensive temperature control options. By controlling the individual LEDs, you can precisely adjust the temperature from cool white to warm or red, depending on the desired atmosphere.

Spec sheet

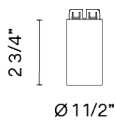

undefined: undefined

Any modifications require a minimum order quantity and extra lead time

Finish	<ul style="list-style-type: none"> 24 Beige M1 NCS S 2005-Y50R 11 Black NCS S 8500-N
LED	2700 K / 3000 K / 3500 K / Tunable Red / Tunable White
Dimming	DALI 0-10V 1-10V / CASAMBI / 0-10V

Installation type To track

LED CRI>90 680 lm 94.4
2700 K / 3000 K / 3500 K / Tunable Red / Tunable White

Driver Constant Current 400 42 V - 48 V V

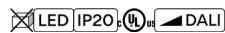

Application Pendants

Packaging Box

Gross weight
Net weight

Lighting effect

Accent Downlight

Narrow: Angles less than 20°. Suitable for generating high contrasts or projections at far distances.



Photometric Data

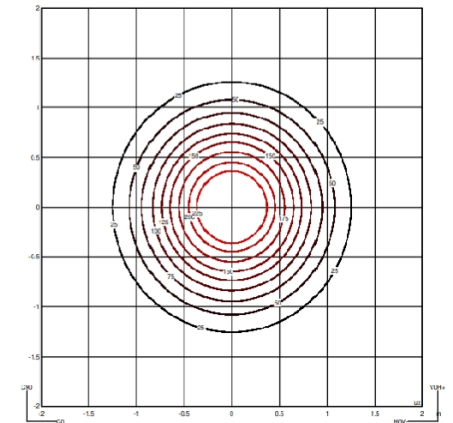
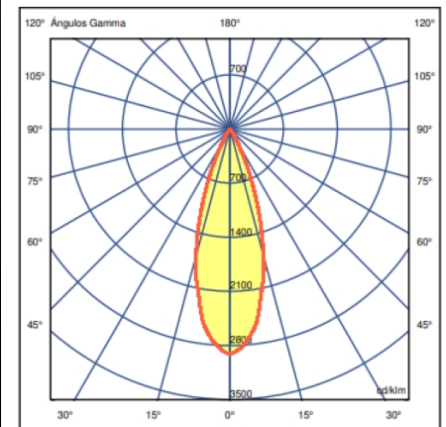

Efficiency	78.001 lm/W
Coordination System	CG
Total Flux	585.0 lm
Maximum Value	2905.10 cd/klm

All of our products come with a two year standard warranty. Check US & Canada Term and Condition sales@vibia.com

Design By Antoni Arola

Circus with its focus of over 40° generates moderate contrasts and projections at close distances. This model allows for status white or tunable white to achieve desired atmosphere.

Spec sheet

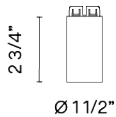

undefined: undefined

Any modifications require a minimum order quantity and extra lead time

Finish	<div style="display: flex; gap: 10px;"> <div style="display: flex; align-items: center;"> <div style="width: 15px; height: 15px; background-color: #c8a28d; border-radius: 50%; margin-right: 5px;"></div> <div> <p>24 Beige M1 NCS S 2005-Y50R</p> </div> </div> <div style="display: flex; align-items: center;"> <div style="width: 15px; height: 15px; background-color: #1a1a1a; border-radius: 50%; margin-right: 5px;"></div> <div> <p>11 Black NCS S 8500-N</p> </div> </div> </div>
LED	2700 K / 3000 K / 3500 K / Tunable White
Dimming	DALI 0-10V 1-10V / CASAMBI / 0-10V

Installation type To track

LED CRI>90 680 lm 94.4
2700 K / 3000 K / 3500 K / Tunable White

Driver Constant Current 400 42 V - 48 V V

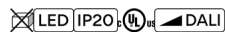

Application Pendants

Packaging Box

Gross weight
Net weight

Lighting effect

Accent Downlight

Narrow: Angles less than 20°. Suitable for generating high contrasts or projections at far distances.



Photometric Data

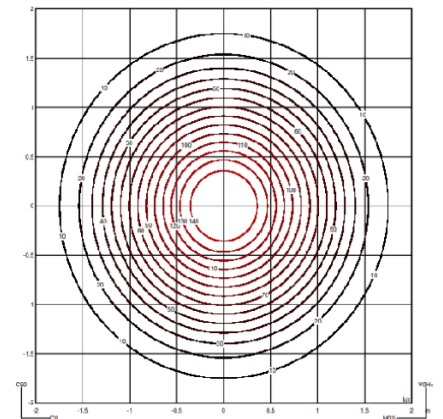
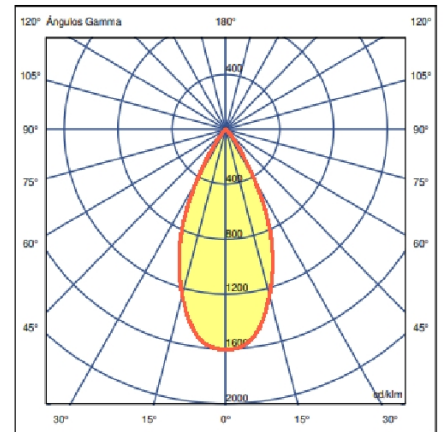

Efficiency	79.258 lm/W
Coordination System	CG
Total Flux	594.4 lm
Maximum Value	1606.43 cd/klm

All of our products come with a two year standard warranty. Check US & Canada Term and Condition sales@vibia.com

Circus

0155

Design By Antoni Arola

VIBIA

The pendant lamp Circus offers a subtly directed diffused light, ideal for lighting applications close to the user. This model is available in various color temperatures from cool white to warm white or red, depending on the LED selection to achieve desired atmosphere.

Spec sheet



Optional: Extra cable length

Min. Quantity, upcharge and extra lead time apply

Finish

● 11 Black
NCS S 8500-N

● 24 Beige M1
NCS S 2005-Y50R

LED

2700 K / 3000 K / 3500 K / Tunable
Red / Tunable White

Dimming

CASAMBI / DALI 0-10V 1-10V / 0-10V

Installation type

To track

LED

CRI>90 1763 lm 137.7
2700 K / 3000 K / 3500 K / Tunable
Red / Tunable White

Driver

Constant Current 400 42 V - 48 V V

LED IP20 DALI

Application

Pendants

Packaging

Box

Gross weight
Net weight

Lighting effect

Close Proximity

Lighting applications for illumination in close proximity to the user

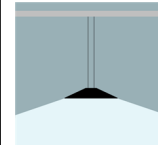

Photometric Data

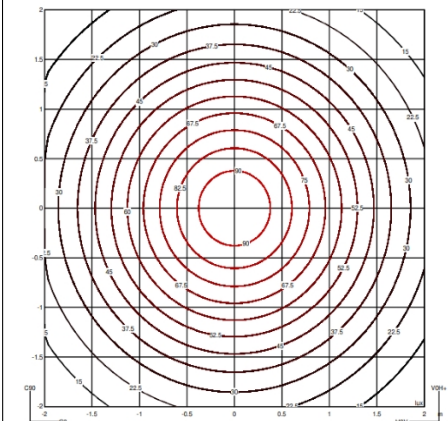
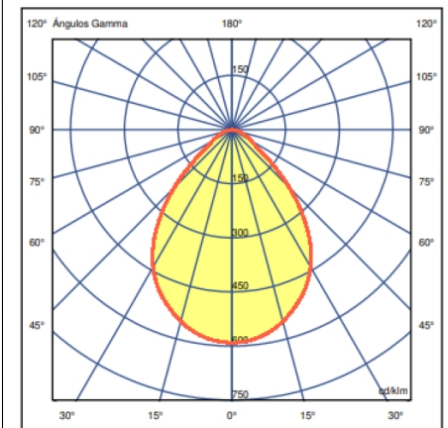

Efficiency 75.802 lm/W
Coordination System CG
Total Flux 1008.2 lm
Maximum Value 591.08 cd/klm

All of our products come with a two year standard warranty. Check US & Canada Term and Condition sales@vibia.com

VIBIA, INC.

Office / Oficina
272 Fernwood Ave. Edison, NJ 08837. USA

International T 732 417 1700
Spain / Portugal T +34 934 796 970

sales@vibia.com
www.vibia.com/us/usa

Design By Antoni Arola

The conical shade of Circus offers subtly directed diffused light, ideal for lighting applications close to the user. This model is available in various color temperatures from cool white to warm or red, depending on the selection of LED.

Spec sheet



- Finish**
- 24 Beige M1
NCS S 2005-Y50R
 - 11 Black
NCS S 8500-N
- LED**
- 2700 K / 3000 K / 3500 K / Tunable
Red / Tunable White
- Dimming**
- CASAMBI / 0-10V / DALI 0-10V 1-10V

Installation type To track

LED CRI>90 1763 lm 137.7
2700 K / 3000 K / 3500 K / Tunable
Red / Tunable White

Driver Constant Current 600 42 V - 48 V V

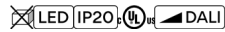

Application Pendants

Packaging Box

Gross weight
Net weight

Lighting effect

Close Proximity

Lighting applications for illumination in close proximity to the user

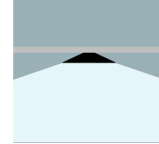

Photometric Data

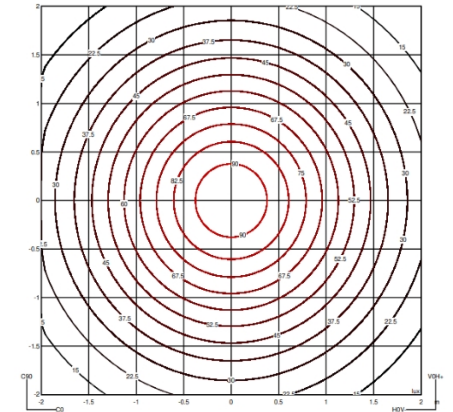
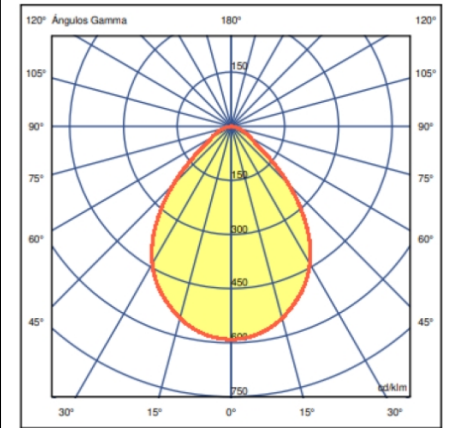

Efficiency 75.802 lm/W
Coordination System CG
Total Flux 1008.2 lm
Maximum Value 591.08 cd/klm

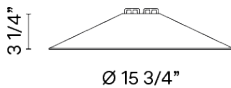

Optional: Extra cable length

Min. Quantity, upcharge and extra lead time apply

All of our products come with a two year standard warranty. Check US & Canada Term and Condition sales@vibia.com

Design By Antoni Arola

The sphere pendant diffuser offers subtly directed and diffused light. This model is available in various color temperatures from cool white to warm or red, depending on the LED selection to achieve desired atmosphere.

Spec sheet

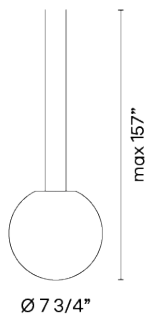
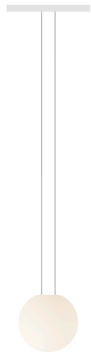

Optional: Extra cable length

Min. Quantity, upcharge and extra lead time apply

Finish	<ul style="list-style-type: none"> 11 Black NCS S 8500-N 24 Beige M1 NCS S 2005-Y50R
LED	2700 K / 3000 K / 3500 K / Tunable Red / Tunable White
Dimming	DALI 0-10V 1-10V / 0-10V / CASAMBI

Installation type To track

LED CRI>90 759 lm 113.4
2700 K / 3000 K / 3500 K / Tunable Red / Tunable White

Driver Constant Current 400 42 V - 48 V V

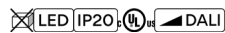

Application Pendants

Packaging Box

Gross weight
Net weight

Lighting effect

Volumetric Diffuser

Subtly directed, diffused light that generates a soft hierarchy of light on to the illuminated surface

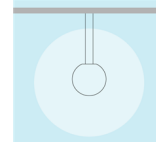

Photometric Data

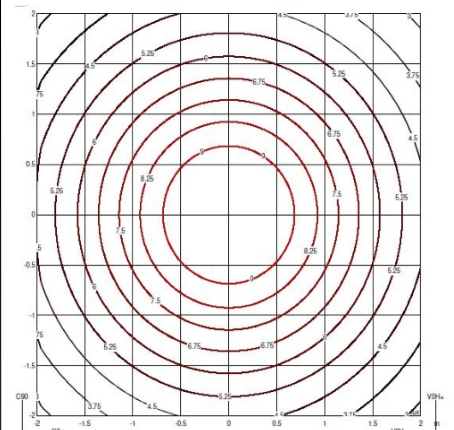
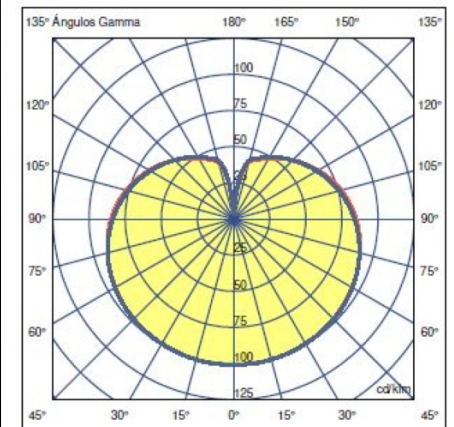

Efficiency	86.571 lm/W
Coordination System	CG
Total Flux	623.3 lm
Maximum Value	100.91 cd/klm

All of our products come with a two year standard warranty. Check US & Canada Term and Condition sales@vibia.com

Circus

0164

Design By Antoni Arola

VIBIA

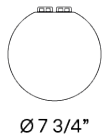
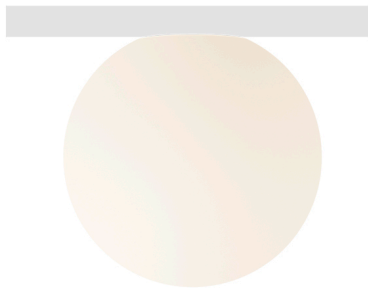

The track-mounted spherical diffuser provides subtly directed and diffused light. This model is available in various color temperatures from cool white to warm white or red, depending on the LED selection to achieve desired atmosphere.

Spec sheet



Optional: Extra cable length

Min. Quantity, upcharge and extra lead time apply

Finish	 11 Black NCS S 8500-N
	 24 Beige M1 NCS S 2005-Y50R
LED	2700 K / 3000 K / 3500 K / Tunable Red / Tunable White
Dimming	0-10V / DALI 0-10V 1-10V / CASAMBI

Installation type To track

LED CRI>90 759 lm 113.4
2700 K / 3000 K / 3500 K / Tunable Red / Tunable White

Driver Constant Current 400 42 V - 48 V V

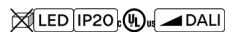

Application Pendants

Packaging Box

Gross weight
Net weight

Lighting effect

Volumetric Diffuser

Subtly directed, diffused light that generates a soft hierarchy of light on to the illuminated surface

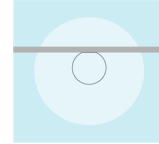

Photometric Data

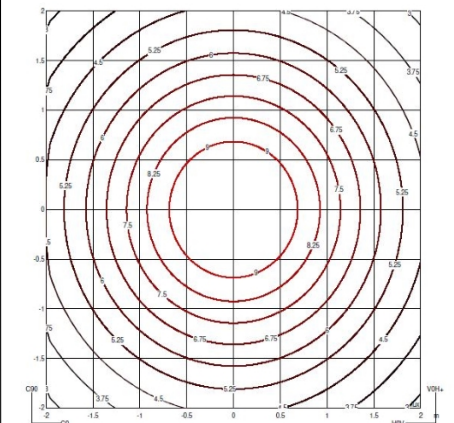
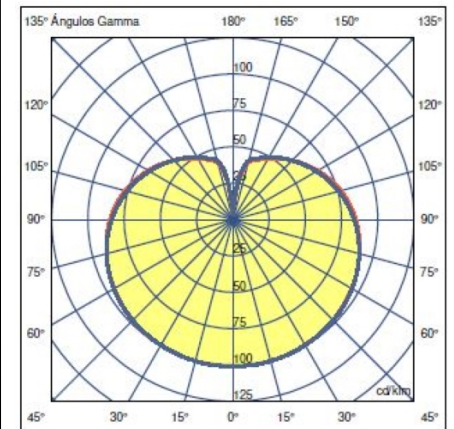

Efficiency	86.569 lm/W
Coordination System	CG
Total Flux	623.3 lm
Maximum Value	100.91 cd/klm

All of our products come with a two year standard warranty. Check US & Canada Term and Condition sales@vibia.com

VIBIA, INC.

Office / Oficina
272 Fernwood Ave. Edison, NJ 08837. USA

International T 732 417 1700
Spain / Portugal T +34 934 796 970

sales@vibia.com
www.vibia.com/us/usa

Circus

0167

VIBIA

Design By Antoni Arola

The large spherical pendant diffuser provides subtly directed and diffused light. This model is available in various color temperatures from cool white to warm or red, depending on the LED selection to achieve desired atmosphere.

Spec sheet

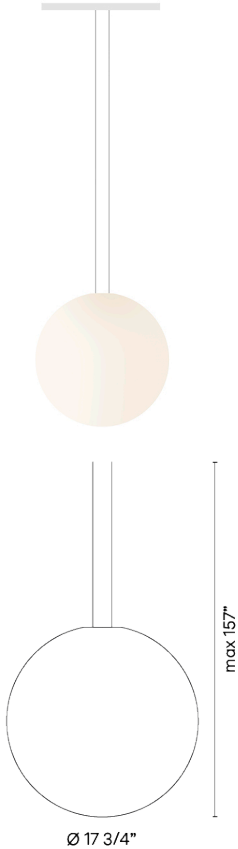

Optional: Extra cable length

Min. Quantity, upcharge and extra lead time apply

Finish

11 Black
NCS S 8500-N

24 Beige M1
NCS S 2005-Y50R

LED

2700 K / 3000 K / 3500 K / Tunable
Red / Tunable White

Dimming

CASAMBI / 0-10V / DALI 0-10V 1-10V

Installation type

To track

LED

CRI>90 2588 lm 132
2700 K / 3000 K / 3500 K / Tunable
Red / Tunable White

Driver

Constant Current 400 42 V - 48 V V

LED IP20 Φ DALI

Application

Pendants

Packaging

Box

Gross weight
Net weight

Lighting effect

Volumetric Diffuser

Subtly directed, diffused light that generates a soft hierarchy of light on to the illuminated surface

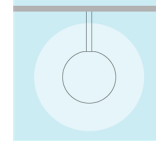

Photometric Data

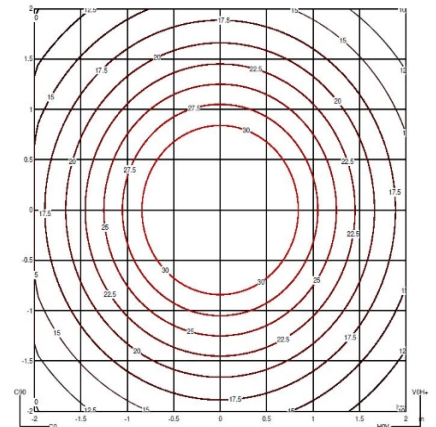
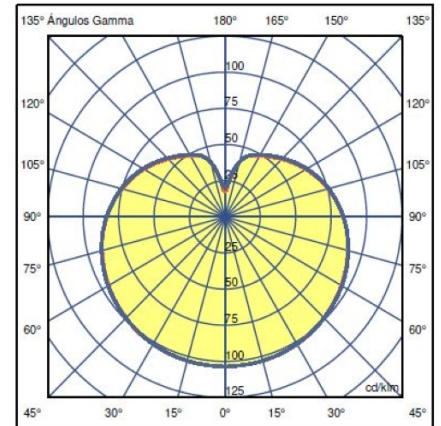

Efficiency 103.014 lm/W
Coordination System CG
Total Flux 2142.7 lm
Maximum Value 103.44 cd/klm

All of our products come with a two year standard warranty. Check US & Canada Term and Condition sales@vibia.com

VIBIA, INC.

Office / Oficina
272 Fernwood Ave. Edison, NJ 08837. USA

International T 732 417 1700
Spain / Portugal T +34 934 796 970

sales@vibia.com
www.vibia.com/us/usa